



The Clear Choice Is Crystal

Vista Series Vinyl Windows & Doors



Replacement & New Construction



Features & Benefits

Both Vista and Vista PLUS windows are designed with features and benefits to enhance your home's beauty and performance.

- *15-point, quality vinyl extrusions assurance program*
- *Nail-on (new construction), Block or Retrofit (replacement) frame*
- *3 1/4" frame depth*
- *Attractive, beveled exterior Retrofit frame*
- *Energy-efficient insulated glass unit with our high-performance Intercept® spacer system*
- *Effortless operation with auto lock and easy sliding*
- *Reinforced meeting rails for added strength*
- *Limited-Lifetime Warranty*



Vista & Vista PLUS

VINYL WINDOWS

Our energy-efficient Vista Series vinyl windows are ideal for your replacement and new construction needs. Choose from our Vista windows or *new* Vista PLUS windows. Both are designed to enhance your home's beauty and performance.

Every window is custom made to your specifications using quality vinyl extrusions and high-performance insulated glass units. Each is constructed to be durable and stylish with features and options that make the Vista Series perfect for your home and family.

Window Comparison

See the difference between Vista and Vista PLUS. And choose the ideal Vista Series window for your replacement or new construction project.

Features	Vista PLUS	Vista
SIGHTLINES	Even	Uneven
INSULATED GLASS UNITS	1"	3/4"
SCREENS	CrystalView™	Standard
WARRANTY – GLASS BREAKAGE	Excluding tempered glass	N/A
WARRANTY – LABOR	Lifetime	10 years

Options	Vista PLUS	Vista
RETROFIT FLANGE ADAPTERS	3/4"	3/4"
COLORS	CrystalCoat™	Clay
WARRANTY – GLASS BREAKAGE	Including tempered glass	N/A



Colors are an approximate representation of our standard coatings. Please ask your Crystal Pacific dealer or representative for samples.



Options

Maximize performance, beauty and style by choosing from our selection of Vista Series glass and grid options.

LE

Increase energy efficiency with LowE2 or LowE3 glass.

Ar

Maximize energy efficiency with LowE3 glass and Argon gas.

GI

Select from a variety of specialty glass options (e.g., obscure, tempered).

Gr

Add beauty and style with sculptured or flat grids.

CrystalView™

VISTA PLUS WINDOW SCREEN

Take a few steps back and your Vista PLUS window screen will seemingly disappear for a clearer view.

CrystalCoat™

EXTERIOR COLOR COATINGS FOR VISTA PLUS

Fuse your Vista PLUS windows into your home's color scheme by choosing from our selection of exterior color coatings.



Vista PLUS Windows

Look to our *new* Vista PLUS windows for even sitemlines and beautiful exterior color options.

Align Vista PLUS with your home's style and color scheme by choosing colonial or marginal grids and the ideal CrystalCoat™ exterior color.

Visibility to the outdoors increases with our CrystalView™ screen, included with Vista PLUS windows.

When you choose Vista PLUS you can be assured that you are covered with lifetime glass breakage and optional tempered glass breakage.

And if you prefer to keep your options simple without sacrificing quality, our popular Vista windows are the clear choice.

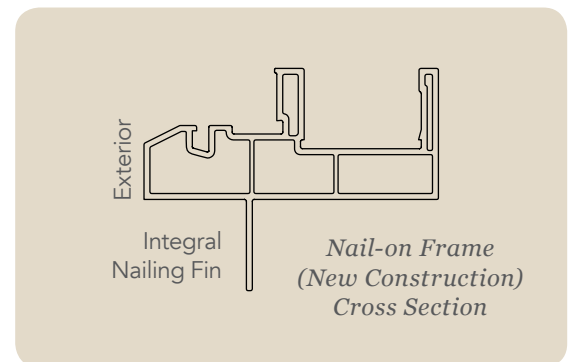
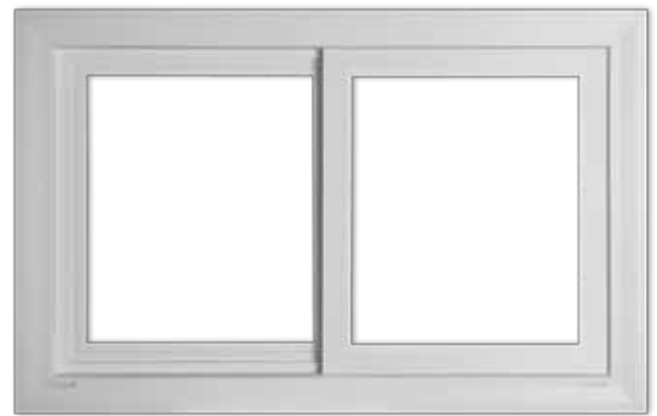

Vista Windows

Our popular high-quality Vista vinyl windows are an excellent choice in white or clay for replacement or new construction projects.

Whether you need to keep it simple or maximize style and energy efficiency with the latest options, Vista windows will meet your needs.

And if you require a little more, our new Vista PLUS windows are the clear choice.



Auto Lock



White and Clay Retrofit (Replacement) Windows

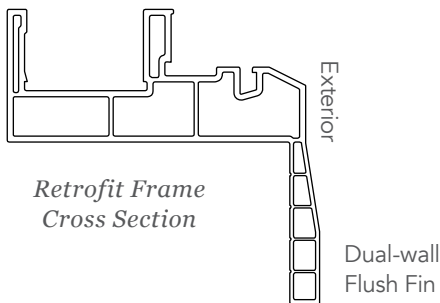

Types & Styles

Choose from a variety of configurations. Or create the perfect combination for your home.

Sliding Windows

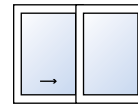

XO

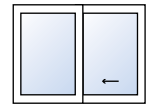

OX

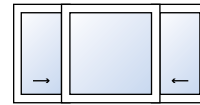

XOX

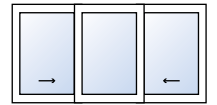

XOX3

Single Hung Windows

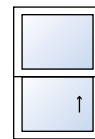

SH

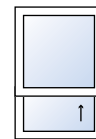

SH3

All viewed from the outside.

Picture & Geometric Windows

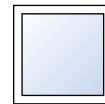

O



Arch

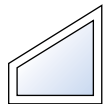

Rake

Casement and awning windows available.

Other geometric shapes available.

Features & Benefits

Our vinyl sliding doors are designed with features and benefits to enhance your patio experience through beauty and performance.

- *15-point, quality vinyl extrusions assurance program*
- *Nail-on (new construction), Block or Retrofit (replacement) frame*
- *5 1/4" frame depth*
- *Attractive, beveled exterior Retrofit frame*
- *Energy-efficient, tempered insulated glass unit with our high-performance Intercept® spacer system*
- *Easy sliding with adjustable rollers*
- *2-panel field reversible, up to 6' 8"*
- *Secure-point locking*
- *Reinforced meeting rails for added strength*
- *Durable, extruded-aluminum, adjustable screen*
- *Limited-Lifetime Warranty*



Sliding Doors

2-, 3- & 4-PANEL

Our energy-efficient vinyl sliding/patio doors were created to compliment our Vista Series vinyl windows for replacement and new construction projects. Our vinyl sliding doors are designed to enhance your patio experience with beauty and performance.

Every sliding door is made to your specifications using quality vinyl extrusions and high-performance insulated tempered glass units. Each constructed to be durable and stylish with features and options that make our vinyl sliding doors the perfect companion to our Vista Series vinyl windows.

Types & Styles

Choose from a variety of configurations to create the perfect patio experience.

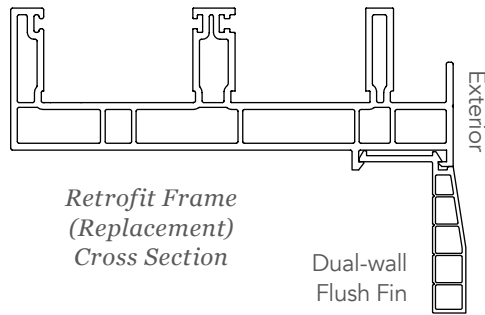

Options

Maximize performance, beauty and style by choosing from our selection of vinyl sliding door options, including glass, grids, locks and rollers.

- LE** Increase energy efficiency with LowE2 or LowE3 glass.
- Ar** Maximize energy efficiency with LowE3 glass and Argon gas.
- Gr** Add beauty and style with sculptured or flat grids.
- Ad** In addition, durable stainless steel rollers, dual-point lock for added security, and retrofit sill available.

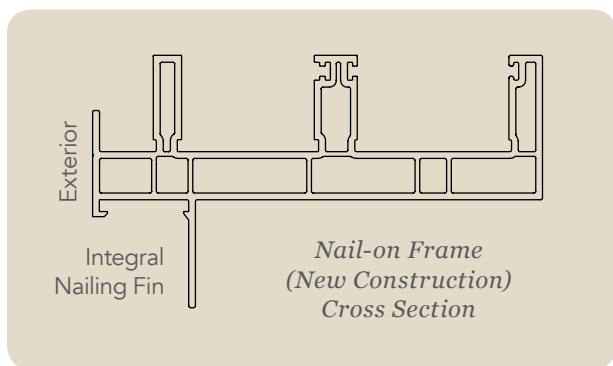

2-Panel

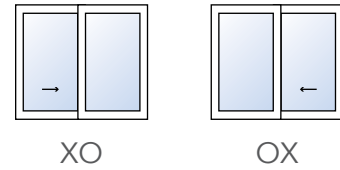

3-Panel

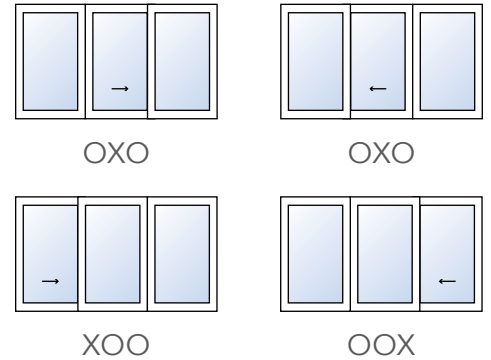

4-Panel

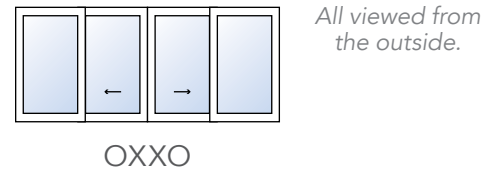

Grids

Choose flat or sculptured grids to maximize style.



5/8"
Flat Grid



1" or 3/4"
Sculptured Grid



Vista Series Vinyl Windows & Doors

Specialty Glass

Add beauty and privacy by choosing from our selection of specialty glass. Other types available.

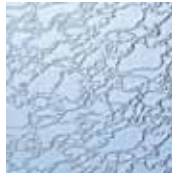

Delta Frost



Glue Chip



Obscure

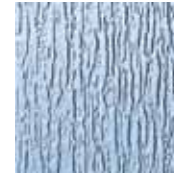

Rain



Reed

RATINGS

LE3/Ar **U-FACTOR** **SHGC**

Windows *Vista, Vista PLUS*

SL 0.31, 0.31 . . 0.22, 0.22

SH 0.30, 0.31 . . 0.22, 0.22

PW 0.27, 0.29 . . 0.24, 0.22

Sliding Doors

PD 0.29 0.22

Windows **PERFORMANCE GRADE**

SL, PW . . LC – PG25

SH LC – PG30

Sliding Doors

PD LC – PG25 / R – PG20



The Clear Choice Is Crystal

LowE3 / Argon
for Title 24



RIVERSIDE, CALIFORNIA
crystalpacificwindow.com

